

tagus®

LUXURY FURNITURE FITMENTS

2023

PRICELIST

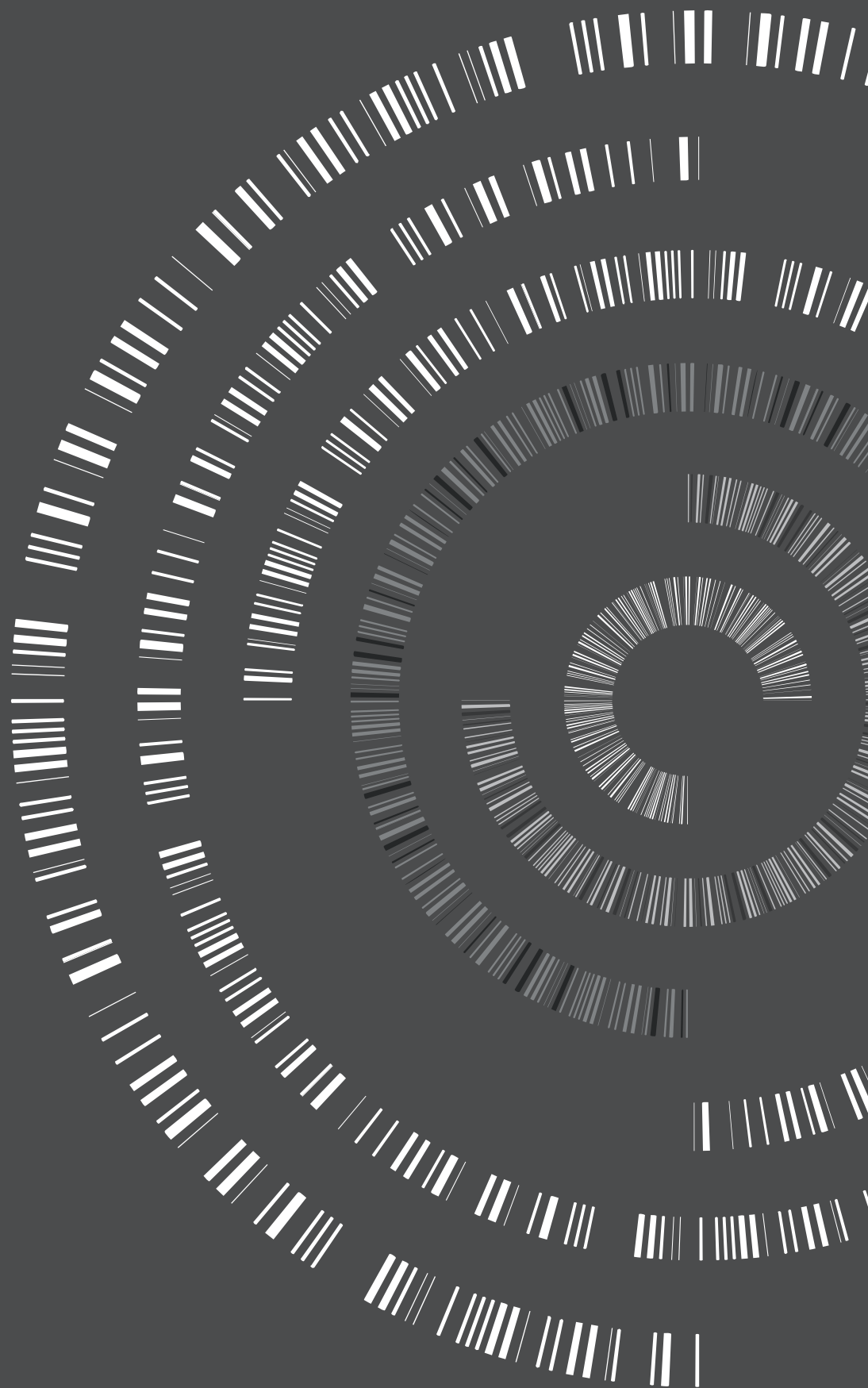

PRODUCT OF TPI GROUP OF COMPANIES

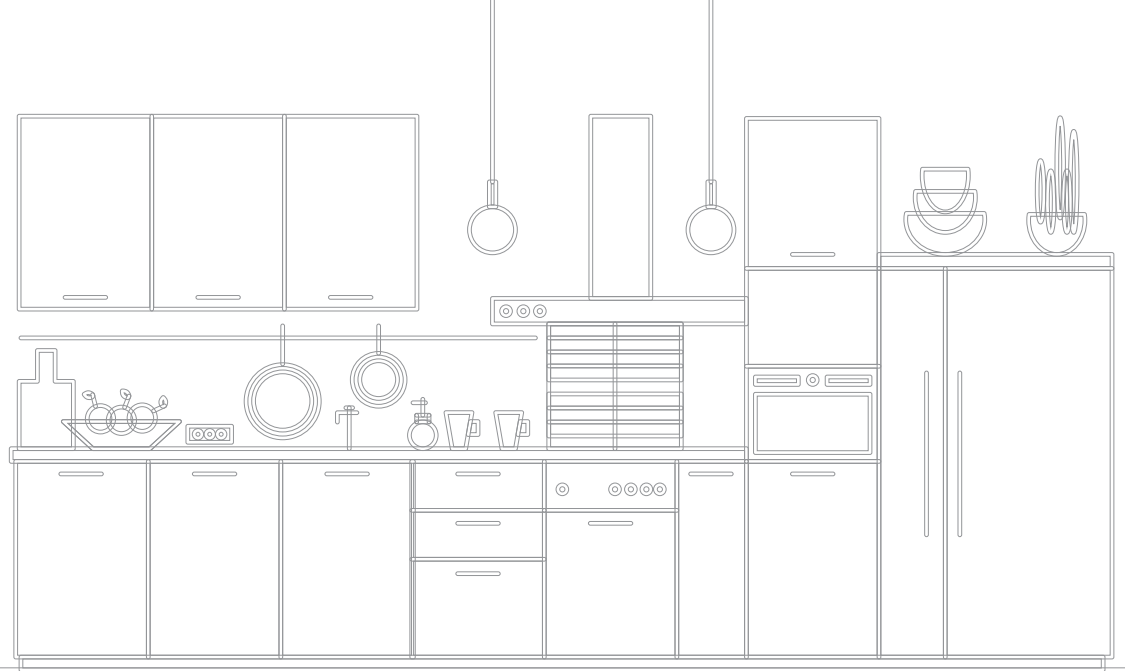

INDEX

| | |
|-------------------------------------|---------|
| About us | 00 - 01 |
| Hinge Systems | 02 - 04 |
| Quanterra Series | 05 - 06 |
| Telescopic Channel | 07 - 07 |
| ABS Cutlery Tray | 08 - 10 |
| Aluminium Profile Series | 11 - 18 |
| Tandem / Slim Drawer Partiton Stand | 19 - 19 |
| Sliding Systems | 20 - 26 |
| Kitchen Accessories | 27 - 35 |
| Aluminium Profile Handle | 36 - 46 |
| Notes | 47 - 47 |



LUXURY FURNITURE FITMENTS

Welcome to Tagus Hardware Concepts, a distinguished brand born from the legacy of our parent company, TPI, with over 30 years of expertise in crafting exquisite Door, Window, and Furniture Accessories.

At Tagus Hardware Concepts, we pride ourselves on a rich history steeped in craftsmanship and precision. This has been a vision of Mr. Kirti M. Shah, MD of TPI Bearings. With three decades of experience in this industry, we at Tagus Hardware Concepts, commit to perfection and infusing elegance into every detail of our products.

Building on a foundation of excellence and innovation, we have evolved to specialize in luxury furniture fitments, creating bespoke pieces that redefine opulence and functionality.

COMPANY VISION AND GOALS

Our vision is to be the one stop solution for individuals who seek the epitome of luxury in furniture fitments. Our primary goal is to elevate living spaces through the creation of timeless and luxurious furniture fitments. Through collaboration with skilled entrepreneurs, we strive to deliver products that enhance the beauty and functionality of every space they grace. At Tagus Hardware Concepts, we invite you to indulge in the artistry of our creations and experience the luxury of living with unparalleled style.

SOFT - CLOSE HINGE SYSTEMS





HINGE SYSTEMS

| CODE | DESCRIPTION | MRP | UNIT |  |
|------|-------------|-----|------|---|
|------|-------------|-----|------|---|

Slide On Hinge

| | | | | | |
|--------|-----------------------------|-------|-----|-----|---|
| 144010 | Slide On Hinge Full Overlay | 117/- | Set | 100 |  |
| 144011 | Slide On Hinge Half Overlay | 120/- | Set | 100 | |
| 144012 | Slide On Hinge Inset | 123/- | Set | 100 | |

MS Clip On Soft Close Hinge

| | | | | | |
|--------|---|-------|-----|-----|--|
| 144025 | MS Clip On Soft Close Hinges Full Overlay | 290/- | Set | 100 |  |
| 144026 | MS Clip On Soft Close Hinges Half Overlay | 295/- | Set | 100 | |
| 144027 | MS Clip On Soft Close Hinges Inset | 300/- | Set | 100 | |

SS Clip On Soft Close Hinge

| | | | | | |
|--------|----------------------------------|-------|-----|-----|---|
| 144001 | SS Soft Close Hinge Full Overlay | 315/- | Set | 100 |  |
| 144002 | SS Soft Close Hinge Half Overlay | 320/- | Set | 100 | |
| 144003 | SS Soft Close Hinge Inset | 325/- | Set | 100 | |

3D Clip On Soft Close Hinge

| | | | | | |
|--------|--|-------|-----|-----|---|
| 144016 | 3D Clip On Soft Close Hinge Full Overlay | 315/- | Set | 100 |  |
| 144017 | 3D Clip On Soft Close Hinge Half Overlay | 320/- | Set | 100 | |
| 144018 | 3D Clip On Soft Close Hinge Inset | 325/- | Set | 100 | |

SS 3D Clip On Soft Close Hinge

| | | | | | |
|--------|--|-------|-----|-----|---|
| 144022 | SS 3D Clip On Soft Close Hinges Full Overlay | 450/- | Set | 100 |  |
| 144023 | SS 3D Clip On Soft Close Hinges Half Overlay | 455/- | Set | 100 | |
| 144024 | SS 3D Clip On Soft Close Hinges Inset | 460/- | Set | 100 | |

Short Arm Hinge

| | | | | | |
|--------|-----------------|-------|-----|-----|---|
| 144007 | Short Arm Hinge | 180/- | Set | 100 |  |
|--------|-----------------|-------|-----|-----|---|



HINGE SYSTEMS

| CODE | DESCRIPTION | MRP | UNIT |  |
|------|-------------|-----|------|---|
|------|-------------|-----|------|---|

SS Short Arm Hinge Soft Close

| | | | | |
|--------|-------------------------------|-------|-----|-----|
| 144009 | SS Short Arm Hinge Soft Close | 405/- | Set | 100 |
|--------|-------------------------------|-------|-----|-----|



SS Short Arm Hinge

| | | | | |
|--------|--------------------|-------|-----|-----|
| 144008 | SS Short Arm Hinge | 291/- | Set | 100 |
|--------|--------------------|-------|-----|-----|

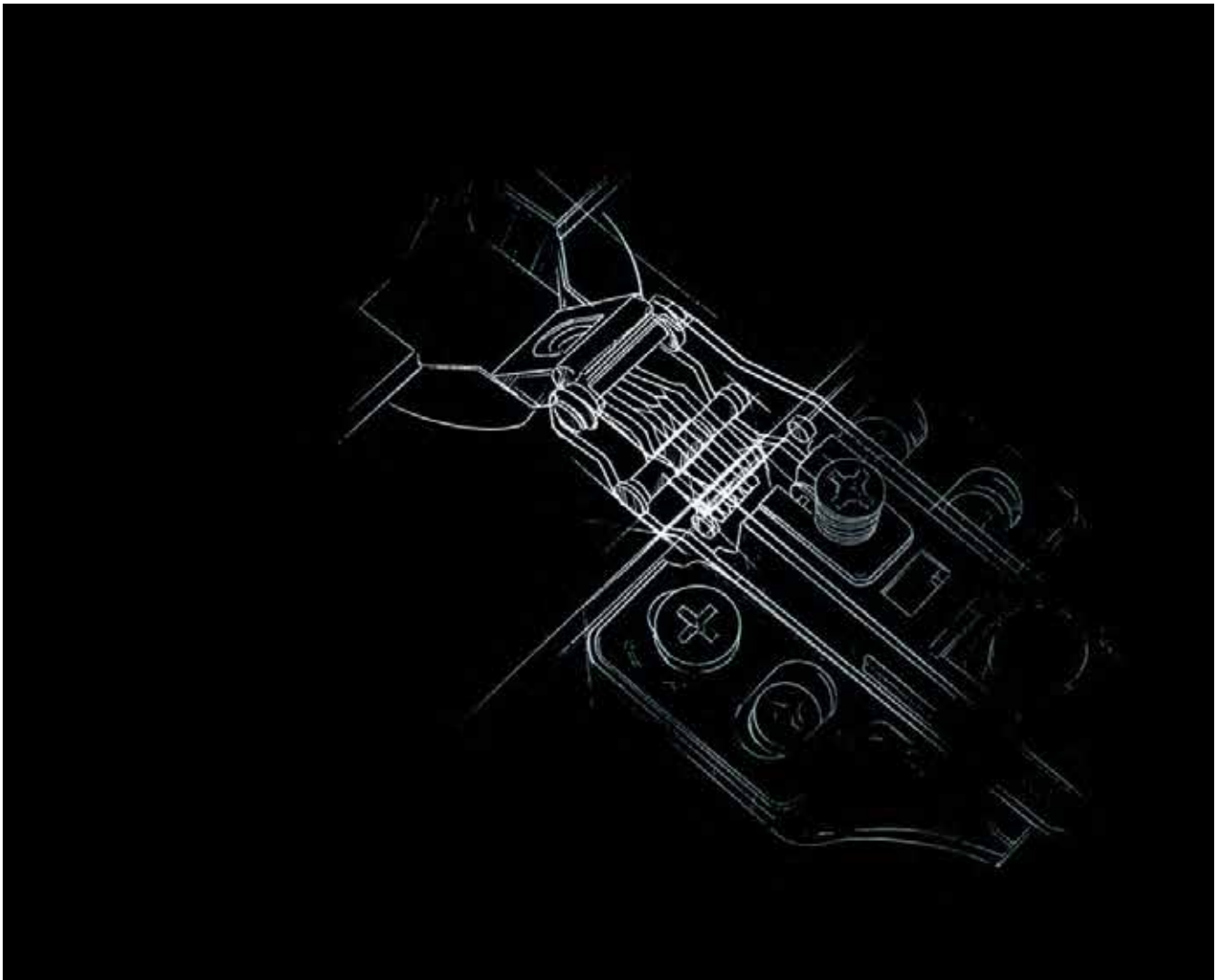



QUANTERRA
SERIES SLIM
DRAWER





QUANTERRA SERIES

| CODE | DESCRIPTION | MRP | UNIT |  |
|------|-------------|-----|------|---|
|------|-------------|-----|------|---|

Quanterra Series Slim Drawer 76mm

| | | | | |
|---------|---|---------|-----|---|
| 1840076 | Quanterra Series Slim Drawer 400m : Ht 76mm | 4484.00 | Set | 6 |
| 1845076 | Quanterra Series Slim Drawer 450m : Ht 76mm | 4534.00 | Set | 6 |
| 1850076 | Quanterra Series Slim Drawer 500m : Ht 76mm | 4729.00 | Set | 6 |
| 1855076 | Quanterra Series Slim Drawer 550m : Ht 76mm | 4929.00 | Set | 6 |

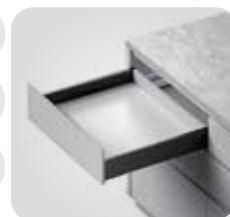

Quanterra Series Slim Drawer 117mm

| | | | | |
|----------|--|---------|-----|---|
| 19400117 | Quanterra Series Slim Drawer 400m : Ht 117mm | 4774.00 | Set | 6 |
| 19450117 | Quanterra Series Slim Drawer 450m : Ht 117mm | 4843.00 | Set | 6 |
| 19500117 | Quanterra Series Slim Drawer 500m : Ht 117mm | 5061.00 | Set | 6 |
| 19550117 | Quanterra Series Slim Drawer 550m : Ht 117mm | 5294.00 | Set | 6 |



Quanterra Series Slim Drawer 164mm

| | | | | |
|----------|--|---------|-----|---|
| 20400164 | Quanterra Series Slim Drawer 400m : Ht 164mm | 5182.00 | Set | 5 |
| 20450164 | Quanterra Series Slim Drawer 450m : Ht 164mm | 5345.00 | Set | 5 |
| 20500164 | Quanterra Series Slim Drawer 500m : Ht 164mm | 5497.00 | Set | 5 |
| 20550164 | Quanterra Series Slim Drawer 550m : Ht 164mm | 5655.00 | Set | 5 |



Quanterra Series Slim Drawer 199mm

| | | | | |
|----------|--|---------|-----|---|
| 21400199 | Quanterra Series Slim Drawer 400m : Ht 199mm | 5573.00 | Set | 4 |
| 21450199 | Quanterra Series Slim Drawer 450m : Ht 199mm | 5736.00 | Set | 4 |
| 21500199 | Quanterra Series Slim Drawer 500m : Ht 199mm | 6046.00 | Set | 4 |
| 21550199 | Quanterra Series Slim Drawer 550m : Ht 199mm | 6209.00 | Set | 4 |





TELESCOPIC SLIDE 3 BALLS

| CODE | DESCRIPTION | MRP | UNIT |  |
|------|-------------|-----|------|---|
|------|-------------|-----|------|---|

Telescopic Slide - 45kg Zinc (3 Balls)

| | | | | |
|--------|----------------------------------|--------|-----|----|
| 180200 | Telescopic Slide 8" - ZINC 45KG | 360.00 | Set | 10 |
| 180250 | Telescopic Slide 10" - ZINC 45KG | 360.00 | Set | 10 |
| 180300 | Telescopic Slide 12" - ZINC 45KG | 432.00 | Set | 10 |
| 180350 | Telescopic Slide 14" - ZINC 45KG | 504.00 | Set | 10 |
| 180400 | Telescopic Slide 16" - ZINC 45KG | 576.00 | Set | 10 |
| 180450 | Telescopic Slide 18" - ZINC 45KG | 648.00 | Set | 10 |
| 180500 | Telescopic Slide 20" - ZINC 45KG | 720.00 | Set | 10 |
| 180550 | Telescopic Slide 22" - ZINC 45KG | 792.00 | Set | 10 |
| 180600 | Telescopic Slide 24" - ZINC 45KG | 864.00 | Set | 10 |



Telescopic Slide - 45kg Black (3 Balls)

| | | | | |
|--------|-----------------------------------|--------|-----|----|
| 181200 | Telescopic Slide 8" - BLACK 45KG | 360.00 | Set | 10 |
| 181250 | Telescopic Slide 10" - BLACK 45KG | 360.00 | Set | 10 |
| 181300 | Telescopic Slide 12" - BLACK 45KG | 432.00 | Set | 10 |
| 181350 | Telescopic Slide 14" - BLACK 45KG | 504.00 | Set | 10 |
| 181400 | Telescopic Slide 16" - BLACK 45KG | 576.00 | Set | 10 |
| 181450 | Telescopic Slide 18" - BLACK 45KG | 648.00 | Set | 10 |
| 181500 | Telescopic Slide 20" - BLACK 45KG | 720.00 | Set | 10 |
| 181550 | Telescopic Slide 22" - BLACK 45KG | 792.00 | Set | 10 |
| 181600 | Telescopic Slide 24" - BLACK 45KG | 864.00 | Set | 10 |





ABS
CUTLERY
TRAY





ABS CUTLERY - 500MM DEPTH

| CODE | DESCRIPTION | MRP | UNIT |  |
|------|-------------|-----|------|---|
|------|-------------|-----|------|---|

ABS Cutlery Tray 450

| | | | | |
|-----------|--|--------|----|----|
| 124450500 | ABS Cutlery Tray 450 x 500mm - Matt Grey | 972.00 | Pc | 10 |
|-----------|--|--------|----|----|



ABS Cutlery Tray 500

| | | | | |
|-----------|--|---------|----|----|
| 124500500 | ABS Cutlery Tray 500 x 500mm - Matt Grey | 1041.00 | Pc | 10 |
|-----------|--|---------|----|----|



ABS Cutlery Tray 600

| | | | | |
|-----------|--|---------|----|----|
| 124600500 | ABS Cutlery Tray 600 x 500mm - Matt Grey | 1180.00 | Pc | 10 |
|-----------|--|---------|----|----|



ABS Cutlery Tray 700

| | | | | |
|-----------|--|---------|----|----|
| 124700500 | ABS Cutlery Tray 700 x 500mm - Matt Grey | 1458.00 | Pc | 10 |
|-----------|--|---------|----|----|



ABS Cutlery Tray 800

| | | | | |
|-----------|--|---------|----|----|
| 124800500 | ABS Cutlery Tray 800 x 500mm - Matt Grey | 1666.00 | Pc | 10 |
|-----------|--|---------|----|----|



ABS Cutlery Tray 900

| | | | | |
|-----------|--|---------|----|----|
| 124900500 | ABS Cutlery Tray 900 x 500mm - Matt Grey | 1978.00 | Pc | 10 |
|-----------|--|---------|----|----|





ABS CUTLERY - 500MM / 550MM DEPTH

| CODE | DESCRIPTION | MRP | UNIT |  |
|------|-------------|-----|------|---|
|------|-------------|-----|------|---|

ABS Cutlery Tray 450

| | | | | |
|-----------|--|---------|----|----|
| 124450550 | ABS Cutlery Tray 450 x 550mm - Metallic Grey | 1320.00 | Pc | 10 |
|-----------|--|---------|----|----|



ABS Cutlery Tray 500

| | | | | |
|-----------|--|---------|----|----|
| 124500550 | ABS Cutlery Tray 500 x 550mm - Metallic Grey | 1400.00 | Pc | 10 |
|-----------|--|---------|----|----|



ABS Cutlery Tray 600

| | | | | |
|-----------|--|---------|----|----|
| 124600550 | ABS Cutlery Tray 600 x 550mm - Metallic Grey | 1570.00 | Pc | 10 |
|-----------|--|---------|----|----|



ABS Cutlery Tray 700

| | | | | |
|-----------|--|---------|----|----|
| 124700550 | ABS Cutlery Tray 700 x 550mm - Metallic Grey | 2345.00 | Pc | 10 |
|-----------|--|---------|----|----|



ABS Cutlery Tray 800

| | | | | |
|-----------|--|---------|----|----|
| 124800550 | ABS Cutlery Tray 800 x 550mm - Metallic Grey | 2720.00 | Pc | 10 |
|-----------|--|---------|----|----|



ABS Cutlery Tray 900

| | | | | |
|-----------|--|---------|----|----|
| 124900550 | ABS Cutlery Tray 900 x 550mm - Metallic Grey | 3070.00 | Pc | 10 |
|-----------|--|---------|----|----|





ALUMINIUM PROFILE SERIES



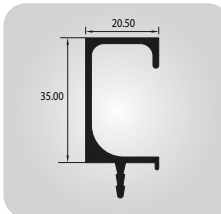
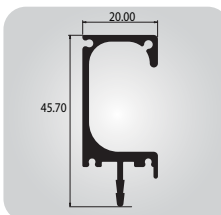
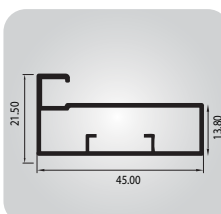
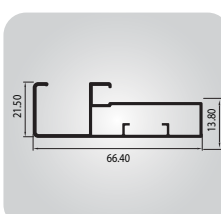
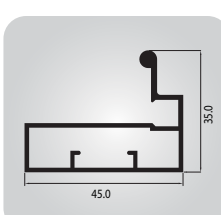
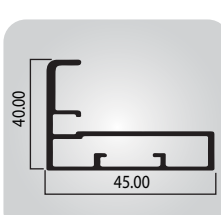

ALUMINIUM PROFILE SERIES

| CODE | DESCRIPTION | MRP | UNIT |  | |
|--------|---|---------|------|---|---|
| 134001 | G Profile Eco Series - 3mtr | 2264.00 | Pc | 10 |  |
| 134002 | G Profile Premium Series - 3mtr | 2569.00 | Pc | 10 | |
| 134003 | G Profile End Cap With 4 Hole Eco Series - 3mtr | 2589.00 | Pc | 10 |  |
| 134004 | G Profile End Cap With 4 Hole Premium Series - 3mtr | 2878.00 | Pc | 10 | |
| 134005 | 45mm Frame Profile Eco Series - 3mtr | 2623.00 | Pc | 10 |  |
| 134006 | 45mm Frame Profile Premium Series - 3mtr | 2824.00 | Pc | 10 | |
| 134007 | 45mm G Frame Profile Eco Series - 3mtr | 3240.00 | Pc | 10 |  |
| 134008 | 45mm G Frame Profile Premium Series - 3mtr | 3585.00 | Pc | 10 | |
| 134009 | 45mm I Frame Profile Eco Series - 3mtr | 2835.00 | Pc | 10 |  |
| 134010 | 45mm J Handle Frame Profile Eco Series - 3mtr | 3260.00 | Pc | 10 |  |

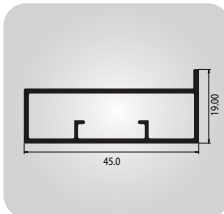
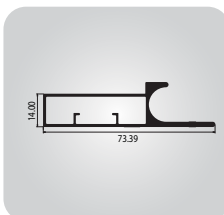
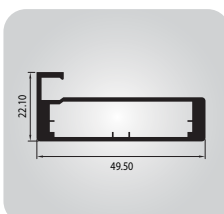
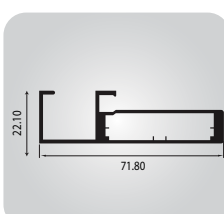
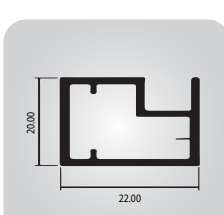

ALUMINIUM PROFILE SERIES

| CODE | DESCRIPTION | MRP | UNIT |  | |
|--------|--|---------|------|---|---|
| 134011 | 45mm Glass Stick Frame Profile - 3mtr Premium Series | 2635.00 | Pc | 10 |  |
| 134012 | 45mm J Glass Stick Frame Profile - 3mtr Premium Series | 3713.00 | Pc | 10 |  |
| 134013 | 49mm Frame Profile 6mm Glass - 3mtr *glass Thickness - 6mm | 3368.00 | Pc | 10 |  |
| 134014 | 49mm G Frame Profile 6mm Glass - 3mtr *glass Thickness - 6mm | 4035.00 | Pc | 10 |  |
| 134015 | 49mm I Frame Profile 6mm Glass - 3mtr *glass Thickness - 6mm | 3662.00 | Pc | 10 |  |
| 134016 | 22mm Frame Profile - 3mtr | 2082.00 | Pc | 10 |  |



ALUMINIUM PROFILE SERIES

| CODE | DESCRIPTION | MRP | UNIT |  | |
|--------|---|---------|------|---|---|
| 134017 | 22mm I Handle Frame Profile | 2478.00 | Pc | 10 |  |
| 134018 | 20mm Frame Profile - 3mtr | 2197.00 | Pc | 10 |  |
| 134019 | 20mm G Handle Frame Profile - 3mtr | 2956.00 | Pc | 10 |  |
| 134020 | 26mm Frame Profile - 3mtr | 3437.00 | Pc | 10 |  |
| 134021 | 26mm Straight Handle Frame Profile - 3mtr | 4513.00 | Pc | 10 |  |
| 134022 | 26mm Curve Handle Frame Profile - 3mtr | 4166.00 | Pc | 10 |  |



ALUMINIUM PROFILE SERIES

| CODE | DESCRIPTION | MRP | UNIT |  | |
|--------|---|---------|------|---|---|
| 134023 | 45MM CURVE EDGE GLASS STICK FRAME PROFILE | 2482.00 | Pc | 10 |  |
| 134024 | 45MM J CURVE EDGE GLASS STICK - 3Mtr HANDLE FRAME PROFILE | 3145.00 | Pc | 10 |  |
| 134025 | 45MM CURVE GLASS STICK FRAME PROFILE - 3Mtr | 2428.00 | Pc | 10 |  |
| 134026 | 45MM J CURVE GLASS STICK - 3Mtr HANDLE FRAME PROFILE | 3087.00 | Pc | 10 |  |
| 134027 | L HANDLE 42MM - 3Mtr | 1860.00 | Pc | 10 |  |
| 134028 | F HANDLE 34MM - 3Mtr | 1840.00 | Pc | 10 |  |



ALUMINIUM PROFILE SERIES

| CODE | DESCRIPTION | MRP | UNIT |  | |
|--------|---|---------|------|---|---|
| 134029 | J HANDLE - 3Mtr | 2494.00 | Pc | 10 |  |
| 134030 | Handle with Gasket | 2247.00 | Pc | 10 |  |
| 134031 | U HANDLE | 2050.00 | Pc | 10 |  |
| 134032 | C GOLA PROFILE - 3Mtr | 2511.00 | Pc | 10 |  |
| 134033 | L GOLA PROFILE - 3Mtr | 2145.00 | Pc | 10 |  |
| 134034 | BOTTOM RUNNING SLIDING SYSTEM TOP & BOTTOM PROFILE 8FT | 3272.00 | Set | 10 |  |



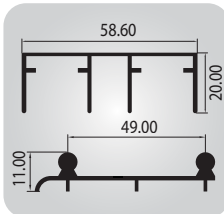
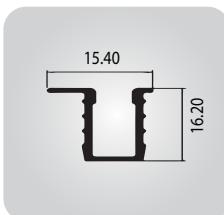
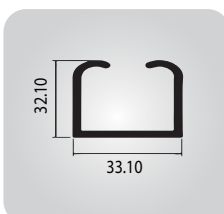
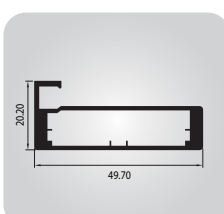
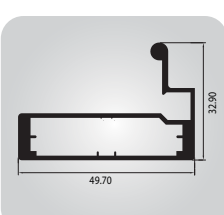
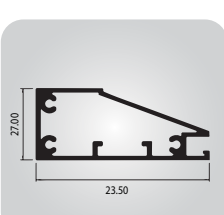

ALUMINIUM PROFILE SERIES

| CODE | DESCRIPTION | MRP | UNIT |  | |
|--------|--|---------|------|---|---|
| 134035 | Bottom Running Sliding System Top & Bottom Profile 12ft | 4526.00 | Set | 10 |  |
| 134036 | Bottom Running Groove Top & Bottom Profile 8Ft | 1227.00 | Pc | 10 |  |
| 134037 | Bottom Running Groove Top & Bottom Profile 12Ft | 1457.00 | Pc | 10 | |
| 134038 | Sliding Partition Door U Track 8ft | 2912.00 | Pc | 10 | |
| 134039 | Sliding Partition Door U Track 12ft | 3986.00 | Pc | 10 |  |
| 134040 | 49mm I Frame Profile - 3Mtr Glass Thickness - 4mm | 3412.00 | Set | 10 |  |
| 134041 | 49mm Frame Profile - 3Mtr Glass Thickness - 4mm | 3067.00 | Pc | 10 |  |
| 134042 | 57mm Curve Vertical Profile | 3828.00 | Set | 10 |  |

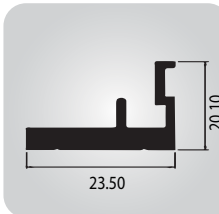
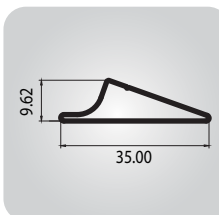
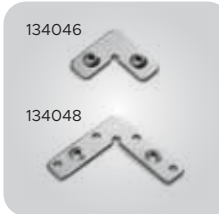

ALUMINIUM PROFILE SERIES

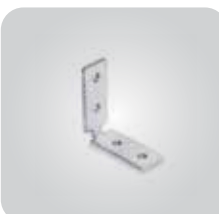
| CODE | DESCRIPTION | MRP | UNIT |  | |
|--------|---|--------|------|---|---|
| 134043 | 23mm Profile Top & Bottom Horizontal Profile | P.O.R | Pc | 10 |  |
| 134044 | Handle For Curve Profile | P.O.R | Pc | 10 |  |
| 134045 | PVC GASKET (3Mtr) - 4mm Glass | 80.00 | Pc | 50 |  |
| 134046 | 20mm Profile Connector (4 pcs set with screw) | 110.00 | Pc | 50 |  |
| 134047 | 62 x 62 Connector for 45mm Profile (4 pcs set with screw) | 178.00 | Set | 50 | |
| 134048 | 57 x 57 Connector for 50mm Profile (4 pcs set with screw) | 190.00 | Set | 50 |  |
| 134049 | Gola Profile Connector (4 pcs set with screw) | 100.00 | Set | 50 |  |



TANDEM / SLIM DRAWER PARTITON STAND

| CODE | DECIPTION | MRP | UNIT |  |
|------|-----------|-----|------|---|
|------|-----------|-----|------|---|

Tandem Partition Cup Saucer Stand

| | | | | |
|---------|---|---------|----|----|
| 1621500 | Tandem Partition Cup Saucer Stand 500mm | 1035.00 | Pc | 10 |
| 1621550 | Tandem Partition Cup Saucer Stand 550mm | 1103.00 | Pc | 10 |



Tandem Partition Plate Stand

| | | | | |
|---------|------------------------------------|---------|----|----|
| 1622500 | Tandem Partition Plate Stand 500mm | 1035.00 | Pc | 10 |
| 1622550 | Tandem Partition Plate Stand 550mm | 1103.00 | PC | 10 |



Tandem Partition Thali Stand

| | | | | |
|---------|------------------------------------|---------|----|----|
| 1623500 | Tandem Partition Thali Stand 500mm | 1035.00 | Pc | 10 |
| 1623550 | Tandem Partition Thali Stand 550mm | 1103.00 | Pc | 10 |



EVA Antiskid Matt

| | | | | |
|-----------|----------------------------------|---------|-----|-------|
| 116085005 | 0.8MM x 500MM X 5MTR - Dark GREY | 1575.00 | Mtr | 5Mtr |
| 116150020 | 1MM x 500MM X 20MTR - Dark GREY | 7550.00 | Mtr | 20Mtr |
| 116155020 | 1MM x 550MM X 20MTR - Dark GREY | 8300.00 | Mtr | 20Mtr |
| 116160020 | 1MM x 600MM X 20MTR - Dark GREY | 9030.00 | Mtr | 20Mtr |

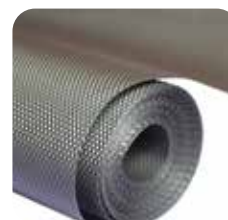



SLIDING SYSTEMS

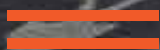



aero SLIDING SYSTEMS FOR 2 DOOR APPLICATION PROFILE LENGTH 3.0MTR

| CODE | DESCRIPTION | MRP | UNIT |  |
|------|-------------|-----|------|---|
|------|-------------|-----|------|---|

aero Sliding Systems

| | | | | |
|----------|--|---------|-----|-----|
| 153001 | HANDLE PROFILE C CURVE- 3.0MTR | 4104.00 | Pc | 10 |
| 153002 | HANDLE PROFILE LINE - 3.0MTR | 4728.00 | Pc | 10 |
| 153003 | HANDLE PROFILE CUBE - 3.0MTR | 6818.00 | Pc | 10 |
| 153004 | TOP PROFILE FOR FRAME - 3.0MTR | 1890.00 | Pc | 10 |
| 153005 | MIDDLE PROFILE FOR FRAME - 3.0MTR | 2100.00 | Pc | 10 |
| 153006 | BOTTOM PROFILE FOR FRAME - 3.0MTR | 3075.00 | Pc | 10 |
| 153007 | TOP TRACK - 3.0MTR | 5175.00 | Pc | 10 |
| 153008 | BOTTOM TRACK - 3.0MTR | 2550.00 | Pc | 10 |
| 153009 | TGSR001 AERO SLIDING KIT 50 KG | 6750.00 | Set | 24 |
| 153010 G | TGWS001G BRUSH WEATHERSTRIP (GREY) | 40.00 | Mtr | 200 |
| 153010 B | TGWS001B BRUSH WEATHERSTRIP (BLACK) | 40.00 | Mtr | 200 |
| 153011 | PVC GASKET | 80.00 | Mtr | 100 |
| 153012 | METAL CLIP | 20.00 | Pc | - |
| 153013 | M5x30 ALLEN SCREW FOR TOP & BOTTOM PROFILE | 16.00 | Pc | 100 |
| 153014 | M6x30 ALLEN SCREW FOR MIDDLE DIVIDER PROFILE | 118.00 | Pc | 100 |

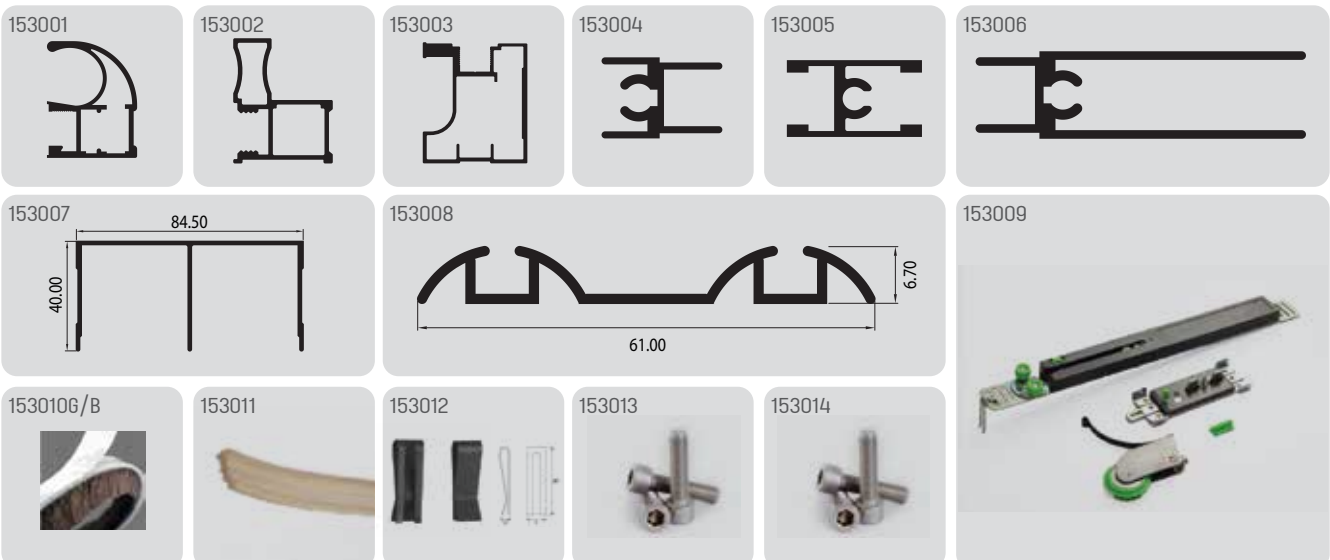



aero SLIDING SYSTEMS FOR 3 DOOR APPLICATION PROFILE LENGTH 3.6MTR

| CODE | DESCRIPTION | MRP | UNIT |  |
|------|-------------|-----|------|---|
|------|-------------|-----|------|---|

aero Sliding Systems

| | | | | |
|----------|--|---------|-----|-----|
| 153001 | HANDLE PROFILE C CURVE- 3.0MTR | 4104.00 | Pc | 10 |
| 153002 | HALDLE PROFILE LINE - 3.0MTR | 4728.00 | Pc | 10 |
| 153003 | HANDLE PROFILE CUBE - 3.0MTR | 6818.00 | Pc | 10 |
| 153004 | TOP PROFILE FOR FRAME - 3.6MTR | 2268.00 | Pc | 10 |
| 153005 | MIDDLE PROFILE FOR FRAME - 3.6MTR | 2520.00 | Pc | 10 |
| 153006 | BOTTOM PROFILE FOR FRAME - 3.6MTR | 3690.00 | Pc | 10 |
| 153007 | TOP TRACK - 3.6MTR | 6210.00 | Pc | 10 |
| 153008 | BOTTOM TRACK - 3.6MTR | 3060.00 | Pc | 10 |
| 153009 | TGSR001 AERO SLIDING KIT 50 KG | 6750.00 | Set | 24 |
| 153010 G | TGWS001G BRUSH WEATHERSTRIP (GREY) | 40.00 | Mtr | 200 |
| 153010 B | TGWS001B BRUSH WEATHERSTRIP (BLACK)) | 40.00 | Mtr | 200 |
| 153011 | PVC GASKET | 80.00 | Mtr | 100 |
| 153012 | METAL CLIP | 20.00 | Pc | - |
| 153013 | M5x30 ALLEN SCREW FOR TOP & BOTTOM PROFILE | 16.00 | Pc | 100 |
| 153014 | M6x30 ALLEN SCREW FOR MIDDLE DIVIDER PROFILE | 118.00 | Pc | 100 |

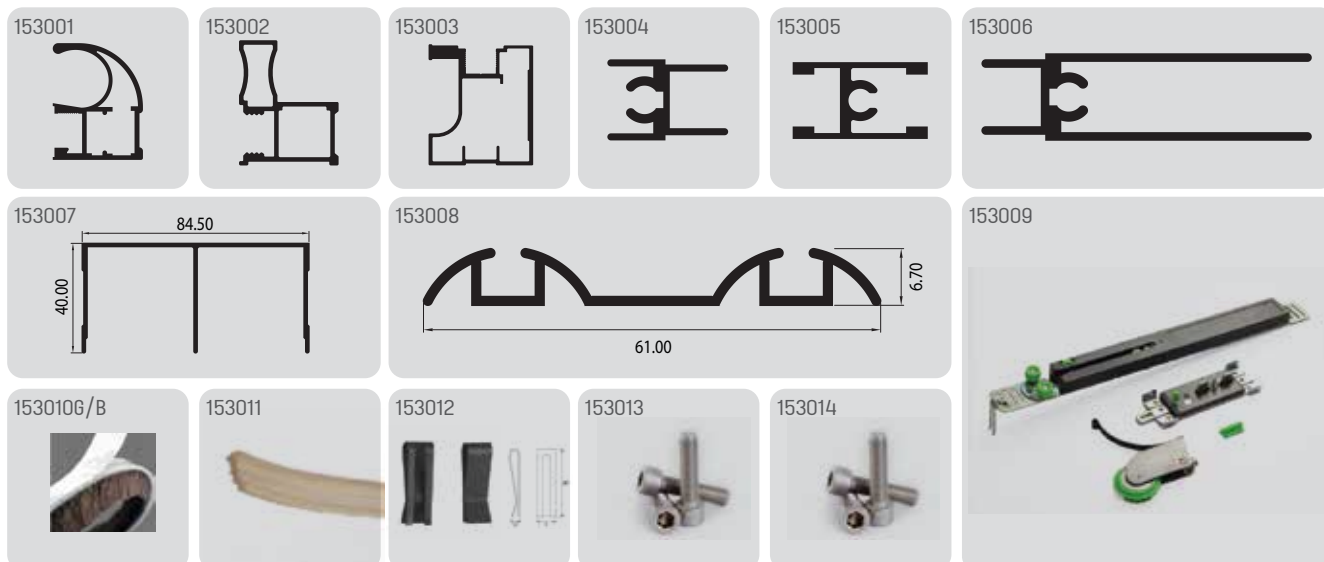



SLICK SLIDING SYSTEMS

| CODE | DESCRIPTION | MRP | UNIT |  |
|------|-------------|-----|------|---|
|------|-------------|-----|------|---|

Slick Sliding Systems



| | | | | |
|---------|---|---------|-----|----|
| 191001 | SLIDING ROLLER KIT /2 DOOR Weight Capacity 50kg / Door | 3060.00 | Set | 20 |
| 191002A | Single Track 8Ft | 720.00 | Pc | 40 |
| 191002B | Single Track 12Ft | 1080.00 | Pc | 40 |
| 191003A | Top Bottom Track 8Ft | 2957.00 | Set | 10 |
| 191003B | Top Bottom Track 12Ft | 4365.00 | Set | 10 |
| 191003C | Top Bottom Track 13Ft | 4725.00 | Set | 10 |
| 191004A | Top Bottom Track With Cover 8Ft | 3262.00 | Set | 10 |
| 191004B | Top Bottom Track With Cover 12Ft | 4824.00 | Set | 10 |
| 191004C | Top Bottom Track With Cover 13Ft | 5220.00 | Set | 10 |
| 191005 | Track 3.6 Mtr | 5265.00 | Set | 10 |

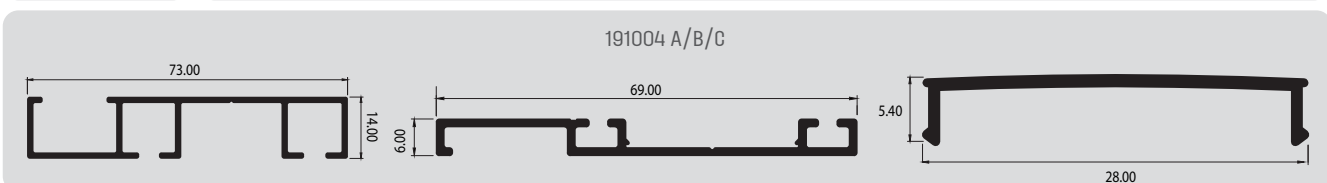
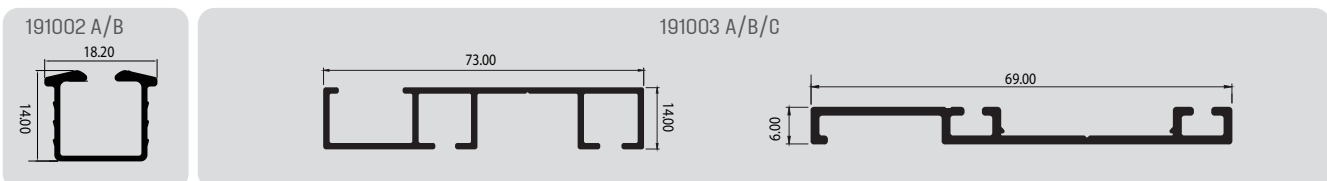



SLICK 2.0 SLIDING SYSTEMS

| CODE | DESCRIPTION | MRP | UNIT |  |
|------|-------------|-----|------|---|
|------|-------------|-----|------|---|

Slick 2.0 Sliding Systems

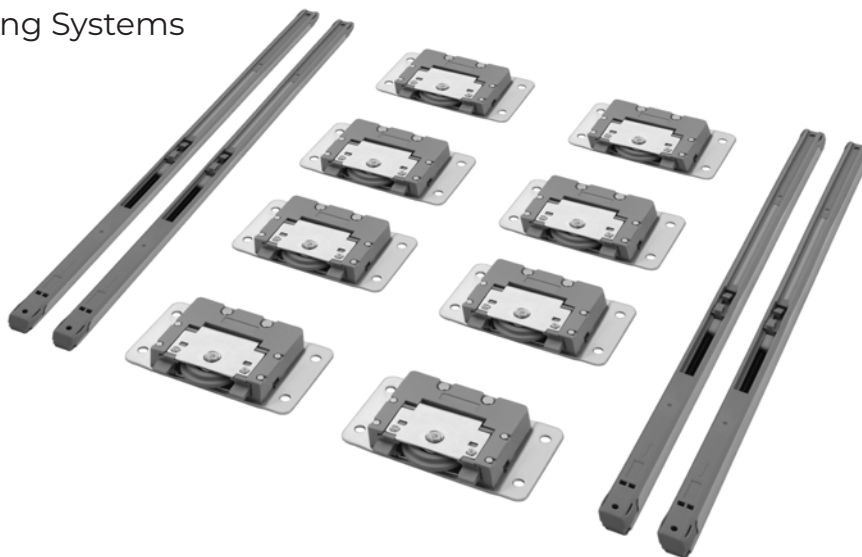

| | | | | |
|--------------|---|---------|-----|----|
| 191001 - 2.0 | SLIDING ROLLER KIT /2 DOOR Weight Capacity 50kg / Door | 3060.00 | Set | 20 |
| 191002A | Single Track 8Ft | 720.00 | Pc | 40 |
| 191002B | Single Track 12Ft | 1080.00 | Pc | 40 |
| 191003A | Top Bottom Track 8Ft | 2957.00 | Set | 10 |
| 191003B | Top Bottom Track 12Ft | 4365.00 | Set | 10 |
| 191003C | Top Bottom Track 13Ft | 4725.00 | Set | 10 |
| 191004A | Top Bottom Track With Cover 8Ft | 3262.00 | Set | 10 |
| 191004B | Top Bottom Track With Cover 12Ft | 4824.00 | Set | 10 |
| 191004C | Top Bottom Track With Cover 13Ft | 5220.00 | Set | 10 |
| 191005 | Track 3.6 Mtr | 5265.00 | Set | 10 |

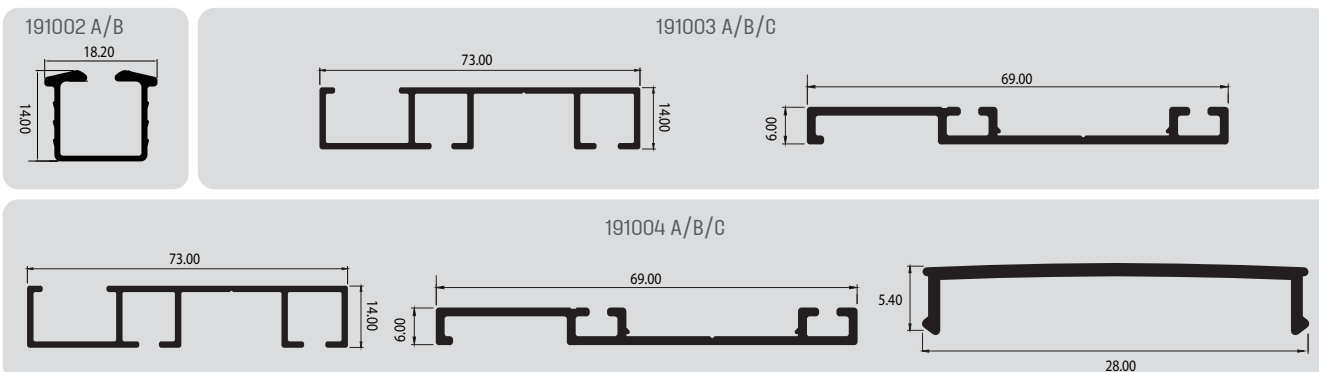



SLIDING SYSTEMS

| CODE | DESCRIPTION | MRP | UNIT |  |
|------|-------------|-----|------|---|
|------|-------------|-----|------|---|

SKM 80AY Bottom Running Sliding Systems Mechanism-80Kg-Double Track



SKM 80AY BOTTOM RUNNING SLIDING MECHANISM 80KG



AL-82 TOP TRACK



134034 / 134035

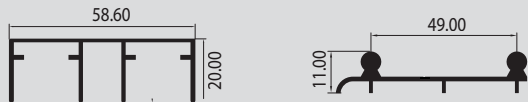

SOFT CLOSE : SFT 008



| | | | | |
|----------|--|---------|-------|-----|
| SKM 80AY | Bottom Running Sliding Mechanism 80 kg - Door Weight Capacity (2 Set) | 1442.00 | 2 Set | 48 |
| 134034 | BOTTOM RUNNING SLIDING SYSTEM TOP & BOTTOM PROFILE 8FT | 3272.00 | Set | 10 |
| 134035 | Bottom Running Sliding System Top & Bottom Profile 12ft | 4526.00 | Set | 10 |
| SFT 008 | Soft Close Mechanism for SKM 80AY | 1333.00 | Pc | 100 |



| CODE | DESCRIPTION | MRP | UNIT |  |
|------|-------------|-----|------|---|
|------|-------------|-----|------|---|

Minifix

| | | | | |
|---------|-----------------|-------|-----|------|
| TGMF001 | 3PC Minifix Set | 16.20 | Set | 2000 |
| TGMF002 | 2PC Minifix Set | 15.20 | Set | 2000 |



Push Open Latch

| | | | | |
|--------|-----------------|-------|-----|-----|
| 176001 | Push Open Latch | 207/- | Set | 600 |
|--------|-----------------|-------|-----|-----|



Sliding Wardrobe Lock

| | | | | |
|----------|---|-------|-----|-----|
| TGSWL001 | Sliding Wardrobe Lock. Suitable for Door Thickness 25mm. | 520/- | Set | 100 |
|----------|---|-------|-----|-----|



Bed Fittings 5mm Thickness

| | | | | |
|---------|------------------------------------|---------|-----|----|
| 174900 | 3ft - Bed Fittings - 5mm Thickness | 2970.00 | Set | 10 |
| 1741200 | 4ft - Bed Fittings - 5mm Thickness | 3330.00 | Set | 10 |
| 1741500 | 5ft - Bed Fittings - 5mm Thickness | 3825.00 | Set | 10 |



Gas Pump

| | | | | |
|--------|---|---------|-----|----|
| 174001 | Gas Pump / Spring - 17" 125 KG / 150 KG / 175 KG / 200 KG / 250 KG | 1415.00 | Set | 10 |
|--------|---|---------|-----|----|





KITCHEN ACCESSORIES





KITCHEN ACCESSORIES

| CODE | DESCRIPTION | MRP | UNIT |  |
|------|-------------|-----|------|---|
|------|-------------|-----|------|---|



Swing Corner White

| | | | | |
|---------|--|---------|----|---|
| 125900L | Swing Corner Left Opening 900mm Softclose - White | 17937/- | Pc | 1 |
| 125900R | Swing Corner Right Opening 900mm Softclose - White | 17937/- | Pc | 1 |



Swing Corner Grey

| | | | | |
|---------|---|---------|----|---|
| 125901L | Swing Corner Left Opening 900mm Both Side Softclose - Grey | 25740/- | Pc | 1 |
| 125901R | Swing Corner Right Opening 900mm Both Side Softclose - Grey | 25740/- | Pc | 1 |



KITCHEN ACCESSORIES

| CODE | DESCRIPTION | MRP | UNIT |  |
|--------|--|---------|------|---|
| 125800 | Universal Magic Corner with Glass Basket 800mm | 32040/- | Pc | 1 |

Universal Magic Corner





KITCHEN ACCESSORIES

| CODE | DESCRIPTION | MRP | UNIT |  |
|------------------------|---|---------|------|---|
| Pantry Pull Out | | | | |
| 127450 | Pantry Pull Out 6 Layer with Glass Basket 450mm | 38540/- | Pc | 1 |
| 127600 | Pantry Pull Out 6 Layer with Glass Basket 600mm | 42075/- | Pc | 1 |
| | *6 Small + 6 Big Basket = 12 Baskets | | | |
| 128450 | Pantry Pull Out 6 Layer with Flat Wire Basket 450mm | 39246/- | Pc | 1 |
| 128600 | Pantry Pull Out 6 Layer with Flat Wire Basket 600mm | 42782/- | Pc | 1 |
| | *6 Small + 6 Big Basket = 12 Baskets | | | |





KITCHEN ACCESSORIES

| CODE | DESCRIPTION | MRP | UNIT |  |
|-----------------|--|---------|------|---|
| Bottle Pull Out | | | | |
| 130200 | Bottle Pullout With 2 Layer Glass Basket 200mm | 9688/- | Pc | 1 |
| 130250 | Bottle Pullout With 2 Layer Glass Basket 250mm | 10041/- | Pc | 1 |
| 130300 | Bottle Pullout With 2 Layer Glass Basket 300mm | 10395/- | Pc | 1 |
| 131200 | Bottle Pullout With 3 Layer Glass Basket 200mm | 11455/- | Pc | 1 |
| 131250 | Bottle Pullout With 3 Layer Glass Basket 250mm | 12162/- | Pc | 1 |
| 131300 | Bottle Pullout With 3 Layer Glass Basket 300mm | 12870/- | Pc | 1 |





KITCHEN ACCESSORIES

| CODE | DESCRIPTION | MRP | UNIT |  |
|------|-------------|-----|------|---|
|------|-------------|-----|------|---|



Adjustable Pull Down Storage

| | | | | |
|--------|---|---------|-----|---|
| 132600 | Adjustable Pull Down Storage - 600mm Grey | 37260/- | Set | 1 |
| 132900 | Adjustable Pull Down Storage - 900mm Grey | 46530/- | Set | 1 |



SS Dish Rack

| | | | | |
|--------|----------------------|--------|-----|---|
| 133600 | SS Dish Rack - 600mm | 2637/- | Set | 5 |
| 133700 | SS Dish Rack - 700mm | 2754/- | Set | 5 |
| 133800 | SS Dish Rack - 800mm | 3105/- | Set | 5 |
| 133900 | SS Dish Rack - 900mm | 3438/- | Set | 5 |



KITCHEN ACCESSORIES

| CODE | DESCRIPTION | MRP | UNIT |  |
|------|-------------|-----|------|---|
|------|-------------|-----|------|---|



Waste Bin

| | | | | |
|--------|---|--------|----|---|
| 135014 | Built In Waste Bin Stainless Steel - 14ltr - 260mm 275 x 330 x 350mm | 3897/- | Pc | 4 |
|--------|---|--------|----|---|



Universal Push Pull Waste Bin

| | | | | |
|--------|---|---------|----|---|
| 135040 | Push Pull Waste Bin - 300mm Wet & Dry Containers 10 Ltr X 2 Containers | 13689/- | Pc | 1 |
|--------|---|---------|----|---|



PVC SKIRTING

| CODE | DESCRIPTION | MRP | UNIT |  |
|------|-------------|-----|------|---|
|------|-------------|-----|------|---|

PVC Skirting

| | | | | | |
|---------|---|---------|----|----|---|
| 136100S | PVC Skirting 100mm Brush Silver-100mm-3 Mtr | 1755.00 | Pc | 10 |  |
| 136100B | PVC Skirting 100mm Matt Black-100mm-3 Mtr | 1755.00 | Pc | 10 |  |

Universal PVC Corner Connector 90°/180°

| | | | | | |
|---------|--|--------|----|----|---|
| 136090S | 90°/180° Universal PVC Corner Connector Brush Silver 100mm | 144.00 | Pc | 10 |  |
| 136090B | 90°/180° Universal PVC Corner Connector Matt Black 100mm | 144.00 | PC | 10 |  |

PVC Corner Connector 180

| | | | | | |
|---------|--|-------|----|----|---|
| 136180S | 180° PVC Corner Connector Brush Silver 100mm | 99.00 | Pc | 10 |  |
| 136180B | 180° PVC Corner Connector Matt Black 100mm | 99.00 | Pc | 10 |  |

Plastic Plinth Adjuster

| | | | | | |
|--------|--|--------|-----|-----|---|
| 137100 | Plastic Plinth Adjuster 100-130mm 4 Legs + 2 Clips | 189.00 | Set | 100 |  100 KG Load Capacity Per Pc |
| 137200 | Plastic Plinth Adjuster 100-130mm 4 Legs + 2 Clips | 243.00 | Set | 50 |  200 KG Load Capacity Per Pc |



PVC ROLLER SHUTTER

| CODE | DESCRIPTION | MRP | UNIT |  |
|------|-------------|-----|------|---|
|------|-------------|-----|------|---|

PVC Roller Shutter

| | | | | |
|---------|--|---------|-----|---|
| 160600B | PVC Roller Shutter Systems Black - 600x1320X260mm | 25110/- | Set | 1 |
| 160600S | PVC Roller Shutter Systems Silver - 600x1320X260mm | 25110/- | Set | 1 |
| 160600W | PVC Roller Shutter Systems White - 600x1320X260mm | 25110/- | Set | 1 |





ALUMINIUM PROFILE HANDLE





DEALER PRICE LIST

504 & 504B ALUMINUM PROFILE HANDLE MRP LIST

GROOVE

| 504 MODEL | ROSEGOLD BRUSH | SILK BLACK | CHROME | UNIT |  |
|--------------|----------------|------------|--------|------|---|
| | SS BRUSH | SILK GREY | | | |
| 6" | 175 | 189 | 175 | Pc | 10 |
| 8" | 234 | 252 | 234 | Pc | 10 |
| 12" | 351 | 378 | 351 | Pc | 10 |
| 16" | 468 | 504 | 468 | Pc | 10 |
| 18" | 526 | 567 | 526 | Pc | 10 |
| 20" | 585 | 630 | 585 | Pc | 10 |
| 24" | 702 | 756 | 702 | Pc | 10 |
| 28" | 819 | 882 | 945 | Pc | 10 |
| 32" | 1080 | 1152 | 1080 | Pc | 10 |
| 36" | 1215 | 1296 | 1215 | Pc | 10 |

BACK SCREW

| 504B MODEL | ROSEGOLD BRUSH | SILK BLACK | CHROME | UNIT |  |
|---------------|----------------|------------|--------|------|---|
| | SS BRUSH | SILK GREY | | | |
| 6" | 189 | 202 | 189 | Pc | 10 |
| 8" | 252 | 270 | 252 | Pc | 10 |
| 12" | 378 | 405 | 378 | Pc | 10 |
| 16" | 504 | 540 | 504 | Pc | 10 |
| 18" | 567 | 607 | 567 | Pc | 10 |
| 20" | 630 | 675 | 630 | Pc | 10 |
| 24" | 756 | 810 | 756 | Pc | 10 |
| 28" | 882 | 945 | 1008 | Pc | 10 |
| 32" | 1152 | 1224 | 1152 | Pc | 10 |
| 36" | 1296 | 1377 | 1296 | Pc | 10 |



DEALER PRICE LIST

505 & 505B ALUMINUM PROFILE HANDLE MRP LIST

GROOVE

| 505 MODEL | ROSEGOLD BRUSH | SILK BLACK | CHROME | UNIT | |
|--------------|----------------|------------|--------|------|----|
| | SS BRUSH | SILK GREY | | | |
| 6" | 175 | 189 | 175 | Pc | 10 |
| 8" | 234 | 252 | 234 | Pc | 10 |
| 12" | 351 | 378 | 351 | Pc | 10 |
| 16" | 468 | 504 | 468 | Pc | 10 |
| 18" | 526 | 567 | 526 | Pc | 10 |
| 20" | 585 | 630 | 585 | Pc | 10 |
| 24" | 702 | 756 | 702 | Pc | 10 |
| 28" | 819 | 882 | 945 | Pc | 10 |
| 32" | 1080 | 1152 | 1080 | Pc | 10 |
| 36" | 1215 | 1296 | 1215 | Pc | 10 |

BACK SCREW

| 505B MODEL | ROSEGOLD BRUSH | SILK BLACK | CHROME | UNIT | |
|---------------|----------------|------------|--------|------|----|
| | SS BRUSH | SILK GREY | | | |
| 6" | 189 | 202 | 189 | Pc | 10 |
| 8" | 252 | 270 | 252 | Pc | 10 |
| 12" | 378 | 405 | 378 | Pc | 10 |
| 16" | 504 | 540 | 504 | Pc | 10 |
| 18" | 567 | 607 | 567 | Pc | 10 |
| 20" | 630 | 675 | 630 | Pc | 10 |
| 24" | 756 | 810 | 756 | Pc | 10 |
| 28" | 882 | 945 | 1008 | Pc | 10 |
| 32" | 1152 | 1224 | 1152 | Pc | 10 |
| 36" | 1296 | 1377 | 1296 | Pc | 10 |



DEALER PRICE LIST

506 & 506B ALUMINUM PROFILE HANDLE MRP LIST

GROOVE

| 506 MODEL | ROSEGOLD BRUSH | SILK BLACK | CHROME | UNIT | |
|--------------|----------------|------------|--------|------|----|
| | SS BRUSH | SILK GREY | | | |
| 6" | 175 | 189 | 175 | Pc | 10 |
| 8" | 234 | 252 | 234 | Pc | 10 |
| 12" | 351 | 378 | 351 | Pc | 10 |
| 16" | 468 | 504 | 468 | Pc | 10 |
| 18" | 526 | 567 | 526 | Pc | 10 |
| 20" | 585 | 630 | 585 | Pc | 10 |
| 24" | 702 | 756 | 702 | Pc | 10 |
| 28" | 819 | 882 | 945 | Pc | 10 |
| 32" | 1080 | 1152 | 1080 | Pc | 10 |
| 36" | 1215 | 1296 | 1215 | Pc | 10 |

BACK SCREW

| 506B MODEL | ROSEGOLD BRUSH | SILK BLACK | CHROME | UNIT | |
|---------------|----------------|------------|--------|------|----|
| | SS BRUSH | SILK GREY | | | |
| 6" | 189 | 202 | 189 | Pc | 10 |
| 8" | 252 | 270 | 252 | Pc | 10 |
| 12" | 378 | 405 | 378 | Pc | 10 |
| 16" | 504 | 540 | 504 | Pc | 10 |
| 18" | 567 | 607 | 567 | Pc | 10 |
| 20" | 630 | 675 | 630 | Pc | 10 |
| 24" | 756 | 810 | 756 | Pc | 10 |
| 28" | 882 | 945 | 1008 | Pc | 10 |
| 32" | 1152 | 1224 | 1152 | Pc | 10 |
| 36" | 1296 | 1377 | 1296 | Pc | 10 |



DEALER PRICE LIST

507 & 507B ALUMINUM PROFILE HANDLE MRP LIST

GROOVE

| 507 MODEL | ROSEGOLD BRUSH | SILK BLACK | CHROME | UNIT |  |
|--------------|----------------|------------|--------|------|---|
| | SS BRUSH | SILK GREY | | | |
| 6" | 175 | 189 | 175 | Pc | 10 |
| 8" | 234 | 252 | 234 | Pc | 10 |
| 12" | 351 | 378 | 351 | Pc | 10 |
| 16" | 468 | 504 | 468 | Pc | 10 |
| 18" | 526 | 567 | 526 | Pc | 10 |
| 20" | 585 | 630 | 585 | Pc | 10 |
| 24" | 702 | 756 | 702 | Pc | 10 |
| 28" | 819 | 882 | 945 | Pc | 10 |
| 32" | 1080 | 1152 | 1080 | Pc | 10 |
| 36" | 1215 | 1296 | 1215 | Pc | 10 |

BACK SCREW

| 507B MODEL | ROSEGOLD BRUSH | SILK BLACK | CHROME | UNIT |  |
|---------------|----------------|------------|--------|------|---|
| | SS BRUSH | SILK GREY | | | |
| 6" | 189 | 202 | 189 | Pc | 10 |
| 8" | 252 | 270 | 252 | Pc | 10 |
| 12" | 378 | 405 | 378 | Pc | 10 |
| 16" | 504 | 540 | 504 | Pc | 10 |
| 18" | 567 | 607 | 567 | Pc | 10 |
| 20" | 630 | 675 | 630 | Pc | 10 |
| 24" | 756 | 810 | 756 | Pc | 10 |
| 28" | 882 | 945 | 1008 | Pc | 10 |
| 32" | 1152 | 1224 | 1152 | Pc | 10 |
| 36" | 1296 | 1377 | 1296 | Pc | 10 |



DEALER PRICE LIST

508 & 508B ALUMINUM PROFILE HANDLE MRP LIST

GROOVE

| 508 MODEL | ROSEGOLD BRUSH | SILK BLACK | CHROME | UNIT |  |
|--------------|----------------|------------|--------|------|---|
| | SS BRUSH | SILK GREY | | | |
| 6" | 175 | 189 | 175 | Pc | 10 |
| 8" | 234 | 252 | 234 | Pc | 10 |
| 12" | 351 | 378 | 351 | Pc | 10 |
| 16" | 468 | 504 | 468 | Pc | 10 |
| 18" | 526 | 567 | 526 | Pc | 10 |
| 20" | 585 | 630 | 585 | Pc | 10 |
| 24" | 702 | 756 | 702 | Pc | 10 |
| 28" | 819 | 882 | 945 | Pc | 10 |
| 32" | 1080 | 1152 | 1080 | Pc | 10 |
| 36" | 1215 | 1296 | 1215 | Pc | 10 |

BACK SCREW

| 508B MODEL | ROSEGOLD BRUSH | SILK BLACK | CHROME | UNIT |  |
|---------------|----------------|------------|--------|------|---|
| | SS BRUSH | SILK GREY | | | |
| 6" | 189 | 202 | 189 | Pc | 10 |
| 8" | 252 | 270 | 252 | Pc | 10 |
| 12" | 378 | 405 | 378 | Pc | 10 |
| 16" | 504 | 540 | 504 | Pc | 10 |
| 18" | 567 | 607 | 567 | Pc | 10 |
| 20" | 630 | 675 | 630 | Pc | 10 |
| 24" | 756 | 810 | 756 | Pc | 10 |
| 28" | 882 | 945 | 1008 | Pc | 10 |
| 32" | 1152 | 1224 | 1152 | Pc | 10 |
| 36" | 1296 | 1377 | 1296 | Pc | 10 |



DEALER PRICE LIST

510B ALUMINUM PROFILE HANDLE MRP LIST

BACK SCREW

| 510B MODEL | ROSEGOLD BRUSH | SILK BLACK | UNIT |  |
|---------------|----------------|------------|------|---|
| | SS BRUSH | SILK GREY | | |
| 6" | 297.00 | 324.00 | Pc | 10 |
| 8" | 396.00 | 432.00 | Pc | 10 |
| 12" | 594.00 | 648.00 | Pc | 10 |
| 16" | 792.00 | 864.00 | Pc | 10 |
| 18" | 891.00 | 972.00 | Pc | 10 |
| 20" | 990.00 | 1080.00 | Pc | 10 |
| 24" | 1188.00 | 1296.00 | Pc | 10 |
| 28" | 1512.00 | 1638.00 | Pc | 10 |
| 32" | 1728.00 | 1872.00 | Pc | 10 |
| 36" | 1944.00 | 2106.00 | Pc | 10 |



DEALER PRICE LIST

511 & 511B ALUMINUM PROFILE HANDLE MRP LIST

GROOVE

| 511 MODEL | ROSEGOLD BRUSH | SILK BLACK | CHROME | UNIT |  |
|--------------|----------------|------------|--------|------|---|
| | SS BRUSH | SILK GREY | | | |
| 6" | 175 | 189 | 175 | Pc | 10 |
| 8" | 234 | 252 | 234 | Pc | 10 |
| 12" | 351 | 378 | 351 | Pc | 10 |
| 16" | 468 | 504 | 468 | Pc | 10 |
| 18" | 526 | 567 | 526 | Pc | 10 |
| 20" | 585 | 630 | 585 | Pc | 10 |
| 24" | 702 | 756 | 702 | Pc | 10 |
| 28" | 819 | 882 | 945 | Pc | 10 |
| 32" | 1080 | 1152 | 1080 | Pc | 10 |
| 36" | 1215 | 1296 | 1215 | Pc | 10 |

BACK SCREW

| 511B MODEL | ROSEGOLD BRUSH | SILK BLACK | CHROME | UNIT |  |
|---------------|----------------|------------|--------|------|---|
| | SS BRUSH | SILK GREY | | | |
| 6" | 189 | 202 | 189 | Pc | 10 |
| 8" | 252 | 270 | 252 | Pc | 10 |
| 12" | 378 | 405 | 378 | Pc | 10 |
| 16" | 504 | 540 | 504 | Pc | 10 |
| 18" | 567 | 607 | 567 | Pc | 10 |
| 20" | 630 | 675 | 630 | Pc | 10 |
| 24" | 756 | 810 | 756 | Pc | 10 |
| 28" | 882 | 945 | 1008 | Pc | 10 |
| 32" | 1152 | 1224 | 1152 | Pc | 10 |
| 36" | 1296 | 1377 | 1296 | Pc | 10 |



DEALER PRICE LIST

512 & 512B ALUMINUM PROFILE HANDLE MRP LIST

GROOVE

| 512 MODEL | ROSEGOLD BRUSH | SILK BLACK | UNIT | |
|--------------|----------------|------------|------|----|
| | SS BRUSH | SILK GREY | | |
| 6" | 324.00 | 351.00 | Pc | 10 |
| 8" | 432.00 | 468.00 | Pc | 10 |
| 12" | 648.00 | 702.00 | Pc | 10 |
| 16" | 864.00 | 936.00 | Pc | 10 |
| 18" | 972.00 | 1053.00 | Pc | 10 |
| 20" | 1080.00 | 1170.00 | Pc | 10 |
| 24" | 1296.00 | 1404.00 | Pc | 10 |
| 28" | 1638.00 | 1764.00 | Pc | 10 |
| 32" | 1872.00 | 2016.00 | Pc | 10 |
| 36" | 2106.00 | 2268.00 | Pc | 10 |

BACK SCREW

| 512B MODEL | ROSEGOLD BRUSH | SILK BLACK | UNIT | |
|---------------|----------------|------------|------|----|
| | SS BRUSH | SILK GREY | | |
| 6" | 351.00 | 378.00 | Pc | 10 |
| 8" | 468.00 | 504.00 | Pc | 10 |
| 12" | 702.00 | 756.00 | Pc | 10 |
| 16" | 936.00 | 1008.00 | Pc | 10 |
| 18" | 1053.00 | 1134.00 | Pc | 10 |
| 20" | 1170.00 | 1260.00 | Pc | 10 |
| 24" | 1404.00 | 1512.00 | Pc | 10 |
| 28" | 1764.00 | 1890.00 | Pc | 10 |
| 32" | 2016.00 | 2160.00 | Pc | 10 |
| 36" | 2268.00 | 2430.00 | Pc | 10 |

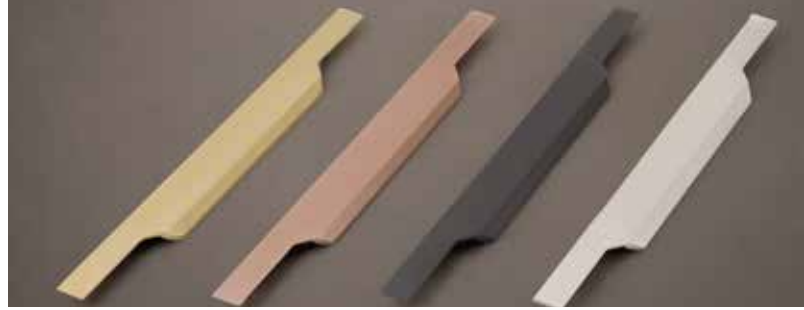

DEALER PRICE LIST

513 & 513B ALUMINUM PROFILE HANDLE MRP LIST

GROOVE

| 513 MODEL | ROSEGOLD BRUSH | SILK BLACK | CHROME | UNIT |  |
|--------------|----------------|------------|--------|------|---|
| | SS BRUSH | SILK GREY | | | |
| 6" | 175 | 189 | 175 | Pc | 10 |
| 8" | 234 | 252 | 234 | Pc | 10 |
| 12" | 351 | 378 | 351 | Pc | 10 |
| 16" | 468 | 504 | 468 | Pc | 10 |
| 18" | 526 | 567 | 526 | Pc | 10 |
| 20" | 585 | 630 | 585 | Pc | 10 |
| 24" | 702 | 756 | 702 | Pc | 10 |
| 28" | 819 | 882 | 945 | Pc | 10 |
| 32" | 1080 | 1152 | 1080 | Pc | 10 |
| 36" | 1215 | 1296 | 1215 | Pc | 10 |

BACK SCREW

| 513B MODEL | ROSEGOLD BRUSH | SILK BLACK | CHROME | UNIT |  |
|---------------|----------------|------------|--------|------|---|
| | SS BRUSH | SILK GREY | | | |
| 6" | 189 | 202 | 189 | Pc | 10 |
| 8" | 252 | 270 | 252 | Pc | 10 |
| 12" | 378 | 405 | 378 | Pc | 10 |
| 16" | 504 | 540 | 504 | Pc | 10 |
| 18" | 567 | 607 | 567 | Pc | 10 |
| 20" | 630 | 675 | 630 | Pc | 10 |
| 24" | 756 | 810 | 756 | Pc | 10 |
| 28" | 882 | 945 | 1008 | Pc | 10 |
| 32" | 1152 | 1224 | 1152 | Pc | 10 |
| 36" | 1296 | 1377 | 1296 | Pc | 10 |



DEALER PRICE LIST

514B ALUMINUM PROFILE HANDLE **MRP LIST**

BACK SCREW

| 514B MODEL | ROSEGOLD BRUSH | SILK BLACK | CHROME | UNIT |  |
|---------------|----------------|------------|--------|------|---|
| | SS BRUSH | SILK GREY | | | |
| 6" | 189 | 202 | 189 | Pc | 10 |
| 8" | 252 | 270 | 252 | Pc | 10 |
| 12" | 378 | 405 | 378 | Pc | 10 |
| 16" | 504 | 540 | 504 | Pc | 10 |
| 18" | 567 | 607 | 567 | Pc | 10 |
| 20" | 630 | 675 | 630 | Pc | 10 |
| 24" | 756 | 810 | 756 | Pc | 10 |
| 28" | 882 | 945 | 1008 | Pc | 10 |
| 32" | 1152 | 1224 | 1152 | Pc | 10 |
| 36" | 1296 | 1377 | 1296 | Pc | 10 |

TERMS & CONDITIONS:

1. GST 18% WILL BE EXTRA.
2. TERMS OF PAYMENT : ADVANCE.
3. PACKING & FORWARDING WILL BE EXTRA.
4. PRICES ARE SUBJET TO CHANGE WITHOUT PRIOR NOTICE.
5. SUBJECT TO RAJKOT JURISDICTION ONLY.

REVISION 02



TAGUS HARDWARE CONCEPTS

Survey No. 212, Plot No. 1, Shed No. 6, Near Vikas Rolling Shutter,
Veraval (Shapar)-360024.Dist. Rajkot, Gujarat. India.

E-mail: tagushardware@gmail.com

www.tagushardware.com

tagusTM

LUXURY FURNITURE FITMENTS

PRODUCT OF **TPI GROUP OF COMPANIES**